

# klimat k7

Swedish-made multifunction fan



## Sweden's most eco-friendly multifunction fan!

**Klimat K7** is an award-winning, Swedish-made multifunction fan with excellent performance, high pressure capacity, low energy consumption, and low sound levels. It can be installed either as a bathroom fan or a Heat mover.

- **Eco-friendly choice**

Consumes a maximum of 3W. Selected materials with low environmental impact, such as PP plastic and halogen-free cables. Packaging made from FSC®-certified paper (no plastic or polystyrene).

- **Easy to install**

Simply screw up the wall frame (integrated seals). Connect live and neutral. Done!

- **Easy to select function**

Lift the cover. Select the mode. Done!

- **Easy to clean**

The motor unit with bayonet fitting makes it easy to dismantle and clean the fan.

### Bathroomfan

- **Klimat K7** has 9 selectable operating modes to handle exhaust air supply in all homes with natural ventilation. A unique self-calibrating motor with a built-in speed controller optimises airflow and prevents cold draughts even when the fan operates at low speed.
- Self-adjusting humidity control
- Presence sensor, activated by movement or light
- Overrun timer, airing function, manual start/stop
- Four speeds for optimal ventilation

Designed and approved (IP44) for installation in wet rooms such as WCs, bathrooms, and utility rooms. Can be mounted on the wall or ceiling (with separate, well-insulated ventilation duct Ø80–125 mm).

### Heat mover

**Klimat K7** has a built-in thermostat that controls the fan to transfer excess heat from, for example, a wood-burning stove to adjacent rooms.



# klimat k7

Packed with technology – yet so simple

For both wall and ceiling installation

**Multiselector**

**Easy switch functions**  
Lift the cover.  
Select the mode.  
Done!



Bayonet fitting  
easy to dismantle  
and clean



**Easy to install!**  
Screw the wall frame in place.  
Connective and neutral.  
Done!

**4 Autostart Presence/Elevated humidity level**  
Presence, medium speed 60 m<sup>3</sup>/h  
Start delay 2.5 minutes  
Humidity, high speed 95 m<sup>3</sup>/h

**5 Manual start/stop via switch**  
High speed 95 m<sup>3</sup>/h

**6 Auto-start + Ventilation function**  
Presence, medium speed 60 m<sup>3</sup>/h  
Humidity, high speed 95 m<sup>3</sup>/h  
*If the fan has been inactive for more than 24 hours, it starts and runs for 30 minutes every 12 hours.*

**9 Extra mode 9: Auto-start at elevated humidity levels**  
Humidity only, high speed 95 m<sup>3</sup>/h

**7 Heat mover**  
Moves excess heat from, e.g., a wood-burning stove to adjacent rooms. Start @ 28°C (95 m<sup>3</sup>/h)  
Stop @ 24°C

**Continuous basic ventilation**

**1 Fully automatic – three speeds**  
Basic flow, low speed 40 m<sup>3</sup>/h  
Presence, medium speed 60 m<sup>3</sup>/h  
Humidity, high speed 95 m<sup>3</sup>/h

**2 When you need extra power**  
Basic flow, low speed 40 m<sup>3</sup>/h  
Presence, medium speed 60 m<sup>3</sup>/h  
Humidity, max speed 110 m<sup>3</sup>/h

**3 Fully automatic – two speeds**  
Basic flow, low speed 40 m<sup>3</sup>/h  
Humidity, high speed 95 m<sup>3</sup>/h

**8 Extra mode 8: Two speeds – increased basic flow**  
Basic flow, medium speed 60 m<sup>3</sup>/h  
Humidity, high speed 95 m<sup>3</sup>/h

**Thermostat**

Ventilation activated on demand



Humidity control



Presence sensor motion (IR) and light



Overrun timer



Speed controller



**Basic flow**  
Low speed 40 m<sup>3</sup>/h



**Presence and light sensor**  
Medium speed 60 m<sup>3</sup>/h



**Humidity control**  
High speed 95 m<sup>3</sup>/h



**Humidity control Max speed**  
Max speed 110 m<sup>3</sup>/h



Silent 17-25 dB  
Low sound level



110 m<sup>3</sup>/h 48 Pa  
Top performance



IP44  
Wet room Zone 1



max 3W  
Energy efficient

## Technical data Bathroom fan Klimat K7

Art.no.	50001 white	50003 black
Placement	Wall or ceiling	
Duct Ø	Ø100 mm (Ø80 – 125)	
Temperature range	5°C to 35°C	
Dimensions	Ø 175 mm, depth 55 mm	
Weight	0,46 kg	
Material	PP Polypropylene (low environmental impact)	
Capacity, free blowing	Low speed	40 m <sup>3</sup> /h      11,1 l/s
	Medium speed	60 m <sup>3</sup> /h      16,7 l/s
	High speed	95 m <sup>3</sup> /h      26,4 l/s
	Max speed	110 m <sup>3</sup> /h      30,6 l/s
Max pressure	48 Pa	
Sound pressure level	17 - 25 dB(A) 3 m	
Electrical installation	Must be installed by a qualified electrician	
Electrical connection	Concealed or surface-mounted	
Voltage/ Frequency	230V AC 50Hz	
Power consumption	Max 3W	
All-pole switch	Yes, built-in	
Motor type	BLDC	
Protection class	IP44 (zone 1)	
Insulation class	Class II, does not require protective earthing	
Certificate	S - Intertek	

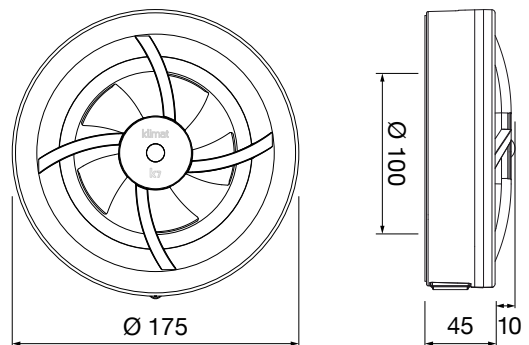

# Assortment



## Bathroom fan Klimat K7

Multifunction fan with excellent performance, high pressure capacity, low energy consumption, and sound level.

White Art. No. 50001  
Black Art. No. 50003



## Bathroom fan Klimat K7 kit

Complete exhaust air kit with Klimat K7 and the necessary accessories for mounting in an external wall.

Art. No. 50002



## Duct kit Ø100 white

Complete duct kit for external walls, includes backdraft shutter, external wall grille #150, and wall pipes Ø100/104 mm.

Art. No. 55022



## Cover plate 195x195

Used when a fan, vent, or accessory does not cover the duct opening (max Ø160 mm). The cover plate is made of PP (polypropylene).

Art. No. 54010



## External wall grille #150

External wall grille 150x150 mm with countersunk screw holes for screw mounting. The grille is made of PP (polypropylene), which has a low environmental impact.

White Art. No. 55031  
Red Art. No. 55033  
Black Art. No. 55032



## External wall grille

With insect net. Fits wall pipes/ metal ductings Ø100 mm. The grille is made of stainless steel.

Art. No. 55001



## Wall vent Klimat K1

Klimat K1 is a complete wall vent, 150x150 mm, designed for wall mounting in homes, storage rooms, and garages

Art. No. 52004



Copyright © Volution Sweden AB  
59011 • Klimatfabriken.se

We accept no liability for printing errors and reserve the right to make changes to materials and designs.